



Precision seed drills
PLANTER 3





Summary

- 04** Regular growth ensured by perfect positioning!
 - 06** Implantation and covering: control yields from the germination!
 - 08** Single bar: a seed-drill for every farmer
 - 10** Single telescopic: for reduced transport width
 - 11** Foldable: ideal for large farms
 - 12** Telescopic with adjustable spacing
 - 14** Upgrade your PLANTER 3 to facilitate the start of your crop
 - 16** Optional equipments
 - 18** Monitor seeding operations from your cab
 - 20** KUHN ISOBUS solutions
 - 22** Technical specifications
-

PLANTER 3

Precision seed drills

PRECISION ON A WIDE SCALE!

MORE THAN A PRECISION SEED DRILL, THE PLANTER 3 IS THE FRUIT OF CAREFUL RESEARCH WHICH GIVES IT EXCEPTIONAL MODULARITY ON ALL SITES USING PRECISION SEEDING.



REGULARITY ENSURED

With the seed drop point very low, the seeds reach the ground at regular intervals and depth, no matter what crop is being sown.

A SEED DRILL TO MEET EVERY USER'S REQUIREMENTS

The new PLANTER 3 range is ideal for mixed farming as well as cereal farms and large contractors.

EXCEPTIONAL MODULARITY

The distance between rows is easily changed to seed two different crops requiring different inter-row spacing. With its many optional equipment, the PLANTER 3 will be a seed drill which meets all your conditions.

PLANTER 3

REGULAR GROWTH ENSURED BY PERFECT POSITIONING!

CONSTANT SPACING BETWEEN SEEDS

The PLANTER 3 was designed for seed by seed distribution with accurate and uniform spacing along the row. The seed drill distribution is suitable for plants with inter-row spacing of more than 25 cm, such as onions, rape, peas, sunflowers, soy, maize, etc.

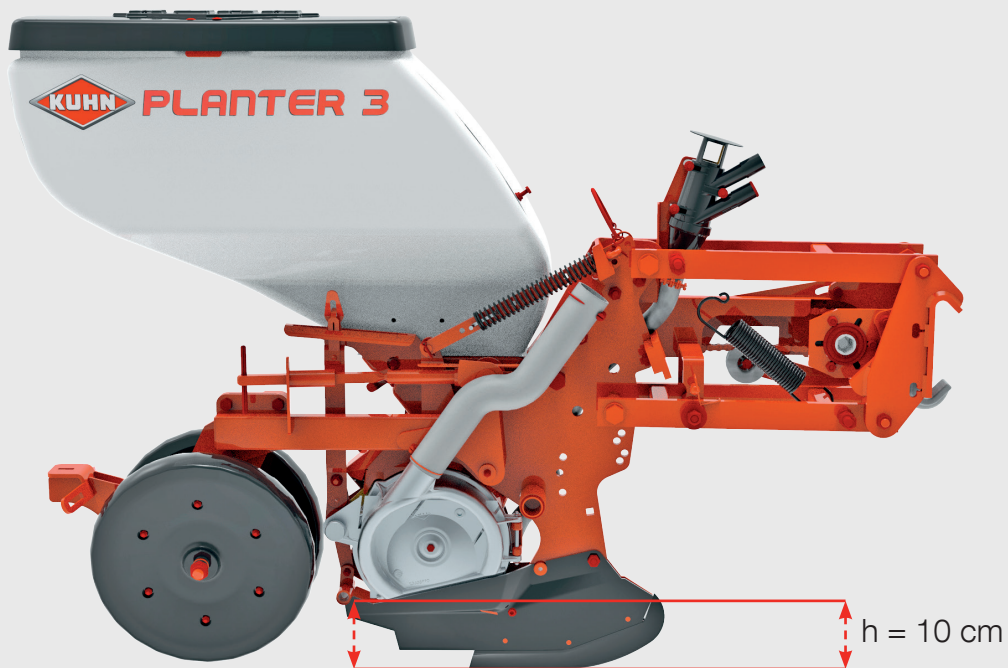

SEEDS RELEASED AT VERY LOW HEIGHT

Even in opener disc versions. The PLANTER is characterized by a very low seed release height: 10 cm from the ground, for greater uniformity between seeds.

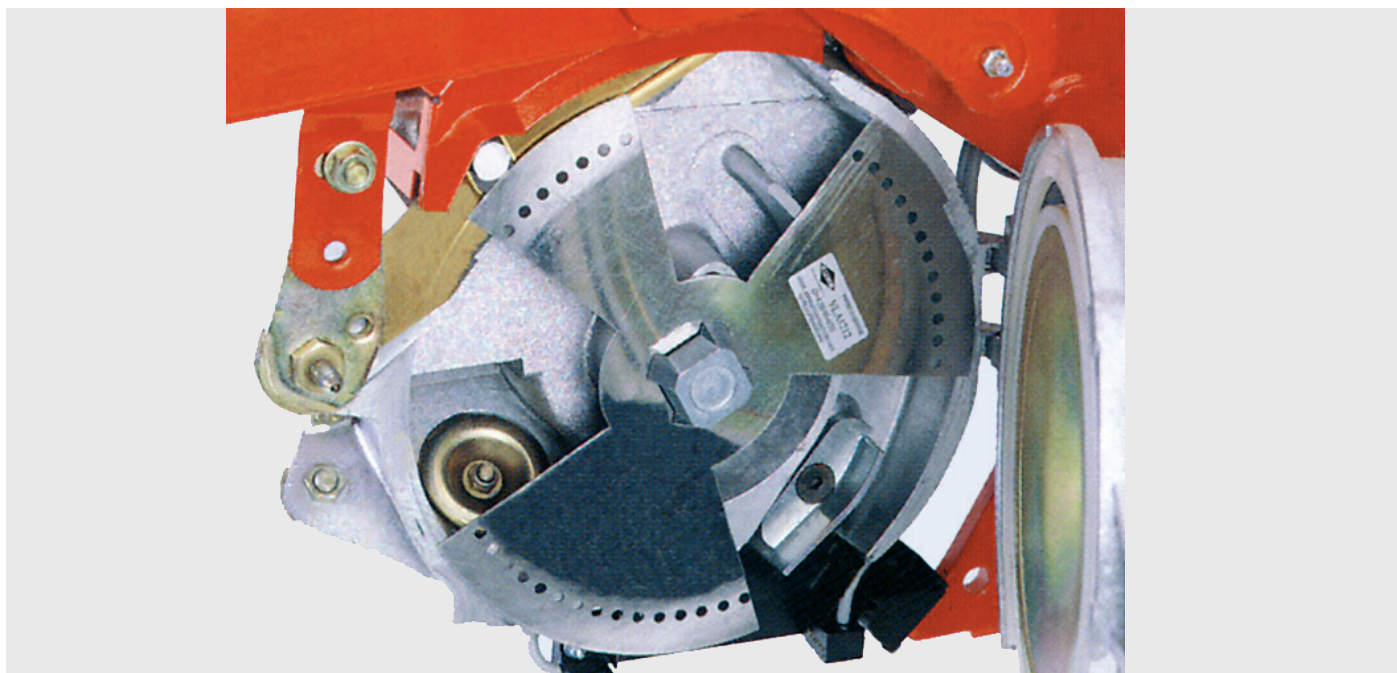

LONG-LASTING DISTRIBUTION!

All the seeding units are characterized by distribution inside an aluminium casing, for long life.

- The grip on the seed by the stainless steel distribution disc is provided by a flow of low-pressure air. The seed is sucked in by the low pressure and held against every perforation on the disc.
- The selection system includes a disc which is appropriate to every crop and a selector which cannot become misadjusted.



For a light-weight seeding unit: rear gauge

This light solution can be used with small tractors to seed in any type of prepared soil. Working depth is controlled by the rear wheels.



For controlled depth: swinging arm

The rear roller and the front wheel follow unevenness in the ground perfectly, with two points of contact with the soil; this system provides incomparable uniformity of depth, particularly for seeding small seeds in well-prepared soil.



For seeding under any conditions: the opening disc unit

For seeding precision under mixed conditions and in the presence of plant debris, seed drop height is as close as possible to the soil to provide uniform positioning between seeds and uniform depth. A real coulter for good seed positioning with seeds inserted between two discs forming a furrow, which helps hold the seed in place.

IMPLANTATION AND COVERING: CONTROL YIELDS FROM THE GERMINATION!

INTERMEDIATE EQUIPMENT: SOLUTIONS ADAPTED TO THE CONSTRAINTS OF EACH USER

The seedbed is opened by coulters which are specially designed for the work you need. The shape of the V-blade, their length, height and profile are the result of many field tests.



BEETROOT COULTER
To release seeds as close to the ground as possible.



LONG MAIZE COULTER
For seeding in abrasive soil.



SHORT MAIZE COULTER
For seeding in light soil.



SPECIFIC COULTER
Opening discs.

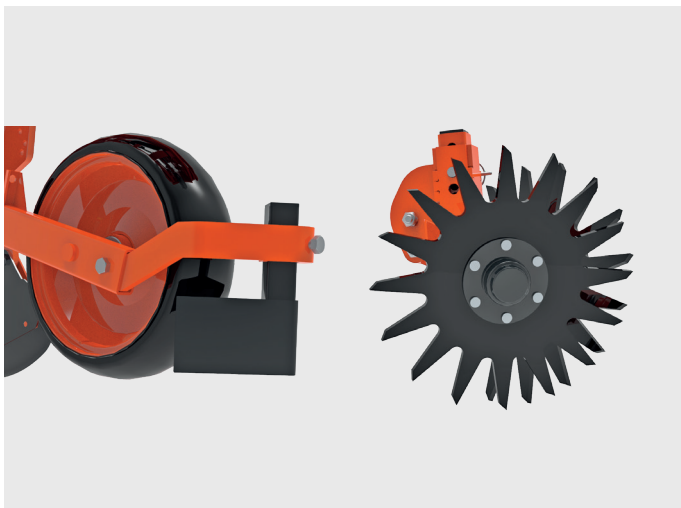

Front equipment: rotary clod cleaner and debris remover

The clod cleaner or trash wiper gets rid of clods, stones or residues on the seeding line. Ideal in stony conditions or on uneven ground, it allows obstacles to be cleared away as the coulters pass.



For fast root development: intermediate wheel

For tamping the seed into the bed before closing it; the seed is tamped into fresh soil, providing it with ideal conditions for good germination. It is available in stainless steel or rubber and can be used for all crops.



REAR WHEELS

They are used to tamp and close the seedbed. Four types of rear wheels, mounted on bearings, are available to meet all working conditions.



Notched V-shaped or smooth wheel on clay or stony soil, to close the furrow and tamp the seed down at the same time.



V-shaped rubber wheel
To close the furrows under all conditions.



OTIFLEX wheel with scrapers for well prepared sandy soil, the scrapers close the furrow which the wheel has tamped.

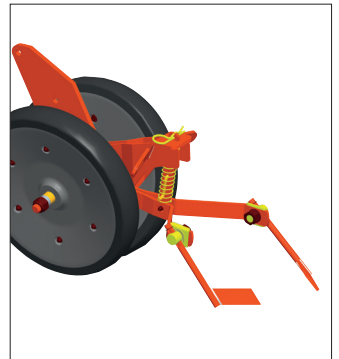

Rear scraper
Suitable for well-prepared soils, it provides soil for the seedbed to cover the seed.

PLANTER 3 M

SINGLE BAR: A SEED-DRILL FOR EVERY FARMER (4 TO 12 ROWS)

For a variety of crops

From 3 to 12 rows and 2.5 m to 9 m, the PLANTER 3's single-bar frame provides a wide possibility of crop establishment, with interrow spacing from 25 cm.

To change the position of a seeding unit, simply loosen a nut and move the seeding unit along the H-beam.







PLANTER 3 TS

SINGLE TELESCOPIC: WIDE AT WORK, COMPACT AT TRANSPORT (6-7-8 ROWS)



For easier transport

From 6 to 8 rows, this single telescopic frame can travel on road with a transport width of 3.00 m or 3.25 m depending on spacing. The outer rows telescope hydraulically inwards.



Seeding combination

The PLANTER 3 TS can be used in combination with a power harrow to save one pass during seeding operations.



PLANTER 3 R

FOLDABLE: IDEAL FOR LARGE FARMS

PLANTER 3 R folding: ideal for large farms

The folding PLANTER 3 has a road width of 3.00 m. The frame is hinged in 3 parts, representing 3 separate seed drills, with the possibility of seeding with 1, 2 or 3 parts. It can therefore cope with any unevenness in the ground for perfect seed positioning.

Combined with a front mounted hopper, it is ideal for large farms and companies. The light, folding, compact frame can be used with tractors from 100 to 130 hp.



TELESCOPIC WITH ADJUSTABLE SPACING: (6-7 ROWS)

SEEDING 45 TO 80 CM WITH ONE MACHINE!

The PLANTER 3 TI and TI M are the ONLY seed drills with spacings adjustable in just a few minutes. This allows farmers to use the same machine for several crops.

The PLANTER 3 TI is available with six rows and spacings from 45 to 80 cm, in order to meet the demand of growers of sugar beet, maize or rape.

The double telescopic PLANTER 3 TI M, for seeding maize over 6 rows or sunflower or rape over 7 rows has optional fertilization and son-board microgranulator features with a transport width of only 3.00 m.

30 minutes seulement sont nécessaires pour passer de la version 6 à 7 rangs.



PATENTED

The significant overlap of the three beams with the robust H-profile gives the frame exclusive rigidity. At maximum opening, the two outer beams overlap the central beam along more than half of their length.





PLANTER 3 TI



PLANTER 3 TI M



Simple adjustments

Row spacings are hydraulically adjusted from the cab. To ensure the right maximum and minimum widths, just one stop each has to be moved.

It is also possible to seed with different spacings, for example to establish tramlines.

Front wheels

Two 23x10 (TI) and 26x12 (TI M) front wheels on the frame always remain between the rows.



PLANTER 3 FERTILIZING OPTIONS

UPGRADE YOUR PLANTER 3 TO FACILITATE THE START OF YOUR CROP!

Different sizes of fertilizer hoppers can be retrofitted on the various PLANTER 3 models. The equipment is optionally mounted on the machine frame, forming a one-part assembly. An optional loading auger for fertilizer in bulk is also available on demand.

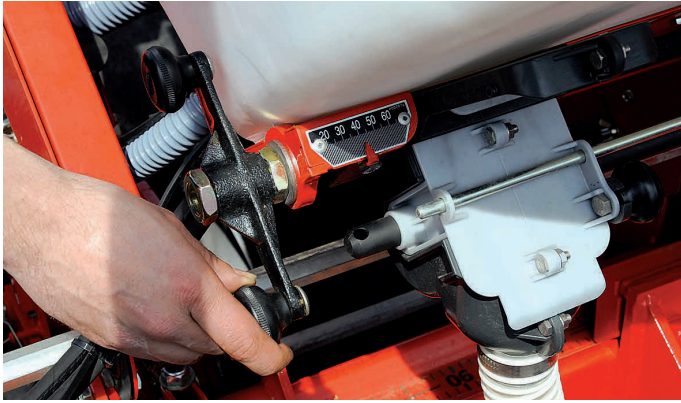

Fluted metering for perfect distribution

Fluted metering ensures a perfectly uniform and smooth distribution throughout the field.

Application rates from 50-700 kg/ha are possible. The separate units are continuously adjustable. The polyurethane groove eliminates any risk of abrasion of the fertilizer.

*depending on the type of fertiliser and the working speed

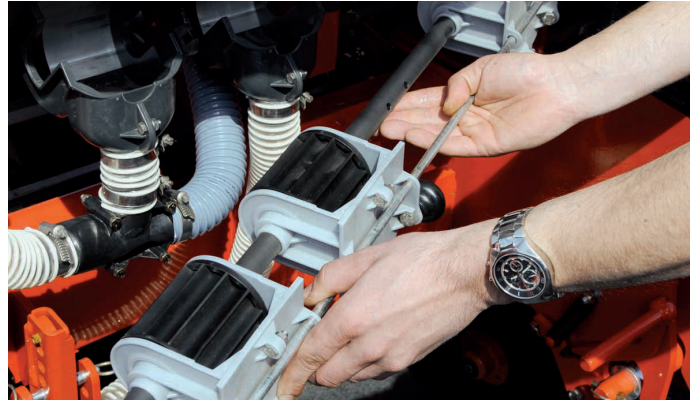

Easy maintenance

You can easily remove the metering unit. This facilitates a complete emptying of the hopper as well as maintenance jobs.

Four types of hoppers are available depending on the chassis:

Designed for loading with a 50 kg bag



2 x 190 l

2 x 260 l

Models for 1 big bag



1 x 950 l

1 x 1350 l

More autonomy with the front hopper KUHN TF 1512

The KUHN TF 1512 can be combined with the PLANTER 3 pneumatic seed drills for fertiliser application. With its large capacity of 1,500 litres (2,000 litres with optional extension) and a transport width of 2.50 m, the hopper is independent, manoeuvrable and compact. A better load balance between the front and rear axles makes manoeuvring easier and reduces soil compaction.



LOCATING THE FERTILIZER 5 CM FROM THE SEED

Different models of fertilizer applicators for different situations

Starter fertiliser is only useful to the plant from the 3 to 12 leaf stage. Before this stage, the plant is too young to absorb the fertiliser. If contact is made, there is a risk of burning, depending on the type of fertiliser. Applicators are positioned 5 cm from the seed line to feed the plant as it grows and to avoid burning the root system formation.

The disc applicator allows to work in the presence of plant residues, it retracts in case of foreign bodies.

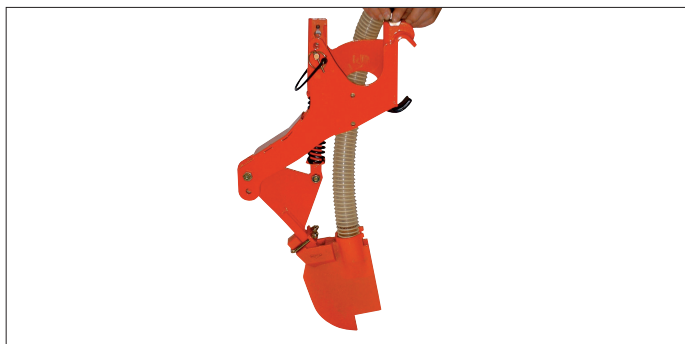
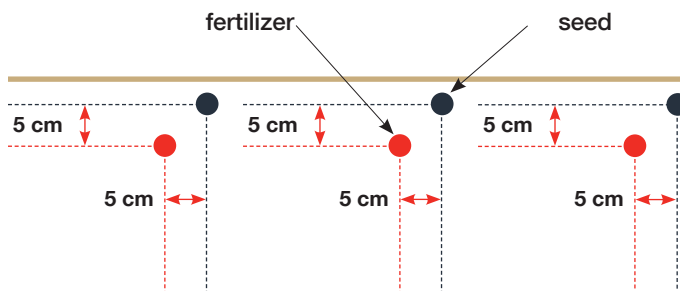

Applicator with non-stop shoe

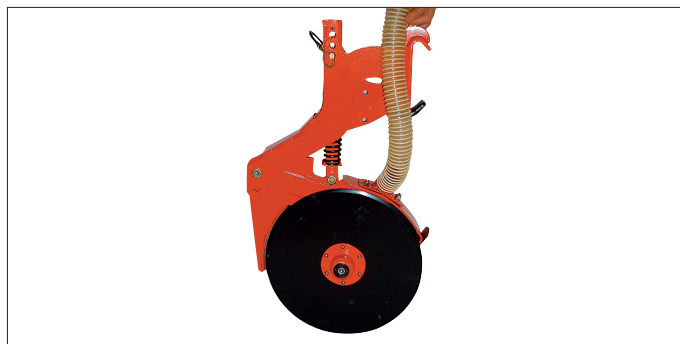

Applicator with non-stop disc for min-tilled fields

CROP PROTECTION

Centralized microgranulator

The centralized hopper allows to limit the handling and to optimize the filling time, the microgranulator can feed up to 9 rows.

The pneumatic transport of the product ensures regular and precise application. It avoids any risk of clogging in the pipes.

The adjustments are made by an index and interchangeable pinions to adapt to each user.

Three types of incorporation:

- Insecticide (in the furrow): flow rate 2.3 to 31 l/ha
- Slug pellets (in-furrow): flow rate 2.3 to 31 l/ha
- High rate (in-furrow): rate 8.5 to 80 l/ha

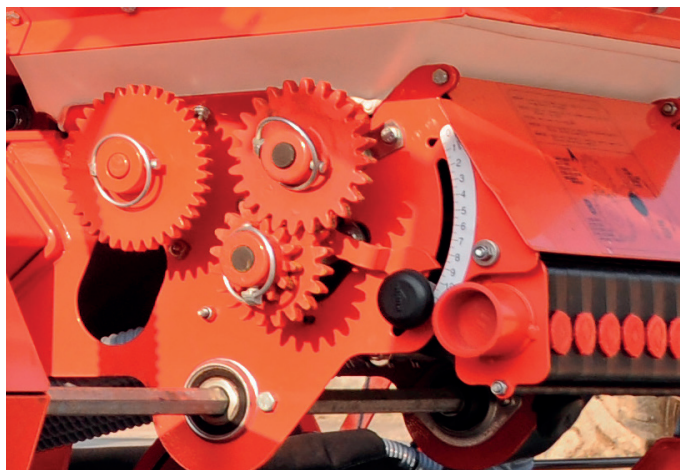

OPTIONAL EQUIPMENT

Numerous options allow you to adapt your seed drill specifically to your conditions. Each farmer has his own particular constraints, sometimes linked to his soil type, his cropping pattern or the requirement for specific crops.

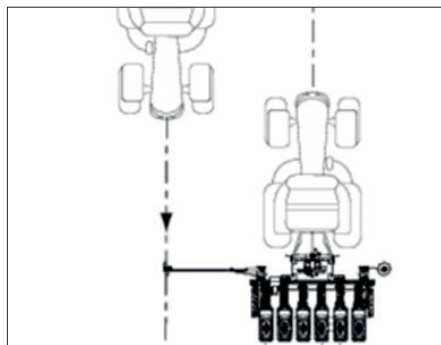
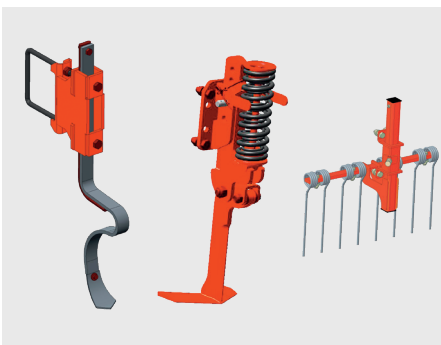

Track eradicator

To remove the traces of the tractor's passage:

- H-beam track eradicator with support for M / TS chassis,
- Spring-loaded track eradicator for R-chassis,
- Track eradicator comb, width 680 mm for R chassis.

Central marking

It allows you to improve your driving comfort when seeding, no need to bend over to follow the track. In addition, you gain in seeding quality with the guarantee of straight seeding.

Markers

Track limiters for marker discs are recommended for sandy soils as they provide a better bearing capacity for the markers.



Vacuum gauge

The vacuum gauge is used to control the vacuum in the system. A constant vacuum in the hoses ensures good seed quality.



Safety cover for fertilizer hopper

They provide optimum protection against external aggression (dust, stones, impacts, etc.).

- Safety cover for fertilizer hopper of 2 x 2601 or 13501.
- Safety cover for fertilizer hopper of 2 x 1901 or 9501.

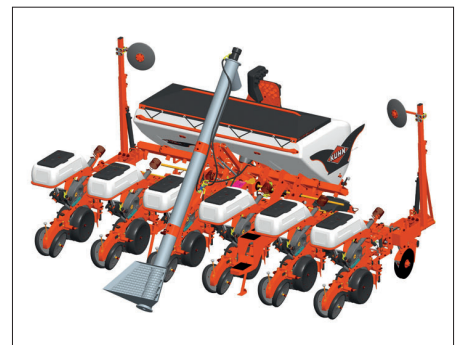

Loading auger

It facilitates the filling of fertiliser hoppers. The screw is made of stainless steel and is hydraulically driven. It is also retractable and has a «Y» output.

MONITOR YOUR SEEDING FROM YOUR CABIN

PLANTER 3 seed drills are available with different versions of electronic control boxes. From the simple control of the seed passage in the seeding units to the precise counting of the seeded population per hectare, KUHN offers a range of reliable and evolving control boxes.

KSM 30

Row by row seed passage controller



4 to 12 rows / red LED lights up = correct seed passage / integrated partial and total hectare counter
Rotation monitoring of the machine drive / Speed display in km/h



KSM 548

Row by row population density monitor



Up to 24 rows / Row declutching/ Detection of small seeds flow / Tramlining possible / Bar graph display for clear indication of defective rows / Possibility to keep an eye on a particular row / Hopper bottom monitoring (optional) / Hopper bottom monitoring (optional) / Partial, seasonal and total hectare counter / Speed display in km/h

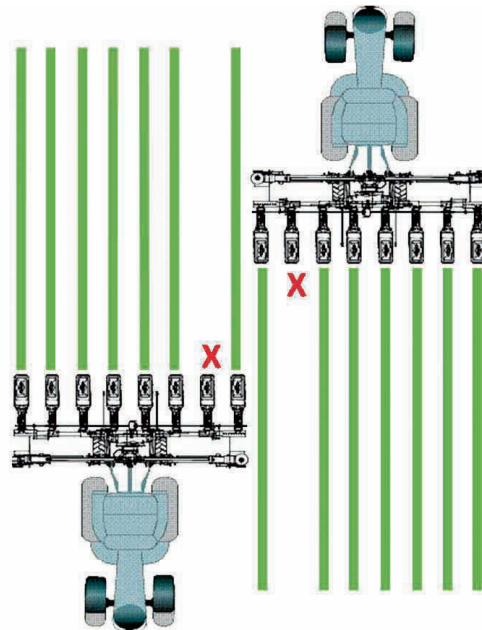

KUHN ISOBUS SOLUTIONS : TAKE ADVANTAGE OF THE ISOBUS COMPATIBILITY ON THE PLANTER 3 RANGE OF SEED DRILLS!



CCI 800 AND CCI 1200: A SINGLE TERMINAL FOR ALL KUHN MACHINES.
CCI 800 and 1200 ISOBUS terminals are AEF-certified. They focus on three priorities: performance, visibility and flexibility. Control intuitively your machines with their large size anti-glare touchscreen. Capable of displaying simultaneously different essential information, accepting the connection of a joystick control and a camera, these terminals offer a high level of flexibility.

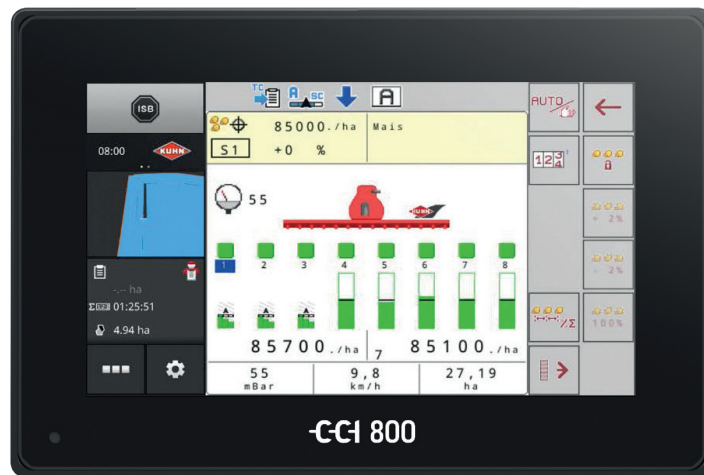

CCI 800: The compact ISOBUS terminal

The 8"/20.3 cm screen displays the main machine and miniviews on the side.
Click on one of the mini-views to switch it to the main screen.



CCI 1200: innovative, large-size, high-performance

With the 12.1"/30.5 cm screen, all essential information is displayed.
Several display layouts are available: miniview / maxiview / double UT.

A MULTITUDE OF APPLICATIONS AS STANDARD



TECU

Retrieve the tractor's basic information



CONTROL

Control your tasks and ISO-XML documentation



CONVERT

Connect to your biomass sensor



CAMÉRA

Connect a camera and display live pictures



HELP SYSTEM

The help you need

DISCOVER THE CCI APPLICATIONS



SECTION CONTROL

Automatic seeding management by D-GPS



RATE CONTROL

Application rate management by GPS (SHP and ISOXML) of several products (ex. seeding + fertilisation)



DATA TRANSFER

Data import/export via agrirouter

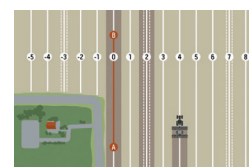

PARALLEL TRACKING

Guidance assistance + tramlining per GPS with the Tramline Control function

Technical Specifications

		PLANTER 3 M						
Seeding units	Rear gauge							
	Swinging arm							
	Opening disc							
Number of rows		4 or 6	4, 5 or 6	6	6 or 8	8	12	
Min/Max spacing (cm)		45 / 80		50	50 / 80	70 / 80	70 / 80	
Frame/transport width (m)		2,50	3,00	3,45	4,40	6,00	9,00	
Possibility of placing the wheels at the front		No			Yes			
Number of wheels		2			4	6		
Minimum inter-row spacing depending on wheel dimensions (cm):	5 x 15							
	6,50 x 15							
	26 x 12							
25 litre hopper								
47 litre hopper								
Type of linkage		Cat. 2 semi-automatic linkage					Cat. 3	
Drive (min-1)								
Number of gearboxes		1				2		
Hydraulic markers								
Fertilizer hopper capacity (l)	2 x 190	◆						
	2 x 260	-	◆				-	
	1 x 950	◆ (except 6 x 45 on 2,50 m)						-
	1 x 1350	-	◆ (except 45 and 50 spacing)					
Fertilization by frontal hopper		-	◆	-	◆			

◆ as standard ◇ optional - unavailable



KUHN PARTS



Designed and manufactured to rival time. KUHN foundries and forge as well as a high-level manufacturing process allow the production of spare parts to defy time. You can truly rely on our know-how and our genuine parts. Farmers benefit from our client support and logistics services via any KUHN PARTS warehouse, which provide quick and reliable repair solutions in cooperation with your nearest authorized KUHN dealer.

PLANTER 3 TS		PLANTER 3 TI	PLANTER 3 TIM	PLANTER 3 R
◆				
◆				
◆				
6 or 7	6 or 7 or 8	6	6 and 7	8, 9, 11 or 12
55 / 75	50 / 80	45 / 80	70 / 80 and 50 / 65	45 / 80
3,00	3,25	2,50		3,00
No		Yes		No
2				4
45				
50				
70				
◆				
◇				
Cat. 2 semi-automatic linkage			Cat. 2	Cat. 3
470 - 540 - 870 - 1 000 (◇ hydraulic drive)				
1				3
◆				
-				
◆	-		◆	-
◆				-
◆ (except 8 rows)	-		◆	-
◆ (except 7 rows)	◆			◆ (except 11 rows)

KUHN SERVICES*

- KUHN sos order** - Express spare parts service 24/7
- KUHN protect+** - The choice of professionals!
- KUHN i tech** - For ever quicker repairs!
- KUHN finance** - Invest rationally!

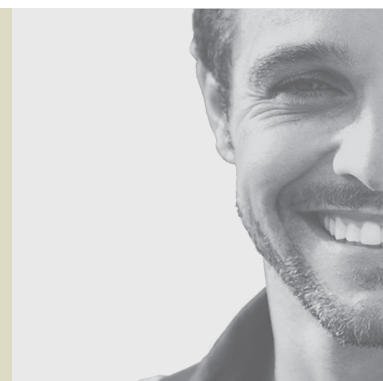

*Not all services and equipment are available in every country. **with the exception of 1 January, 1 May and 25 December

MyKUHNN

THE LINK TO MY SUCCESS

MyKUHNN is your on-line customer space. Sign up now and discover how the exclusive services offered by MyKUHNN will facilitate the management of your fleet of KUHNN machines and terminals as well as help you maximize their performance. Once identified, on computer, smartphone or tablet, you will have access to parts catalogs, technical documentation and numerous connected services.



Discover the KUHNN precision seed drill ranges



1. PLANTER 3 - 2. KOSMA - 3. MAXIMA 3

KUHNN-HUARD SAS - Zone Horizon - 2, Rue de Québec - F-44110 CHATEAUBRIANT - France

For more information about your nearest KUHNN dealer, visit our website www.kuhn.com

Information given in this document is only for information purposes and is non-contractual. Our machines are in compliance with regulations in force in the country of delivery. In our literature, and for improved illustration of certain details, some safety devices may not be in operating position. When operating these machines, these devices must be in position in accordance with the requirements indicated in the operator's manuals and assembly manuals. Respect the tractor gross vehicle weight rating, its lift capacity and maximum load per axle and tyres. The tractor front axle load must always comply with the regulations of the country of delivery (In Europe, it must reach minimum 20% of the tractor net weight). We reserve the right to change any designs, specifications or materials listed without further notice. Machines and equipment in this document can be covered by at least one patent and/or registered design. Trademarks cited in this document may be registered in one or several countries.

To protect the environment, this leaflet is printed on chlorine-free paper.
Printed in France - 950052 GB - 09.21 - Copyright 2021 KUHNN

